

# COMPAC®

FABRIKANT SINDS 1946

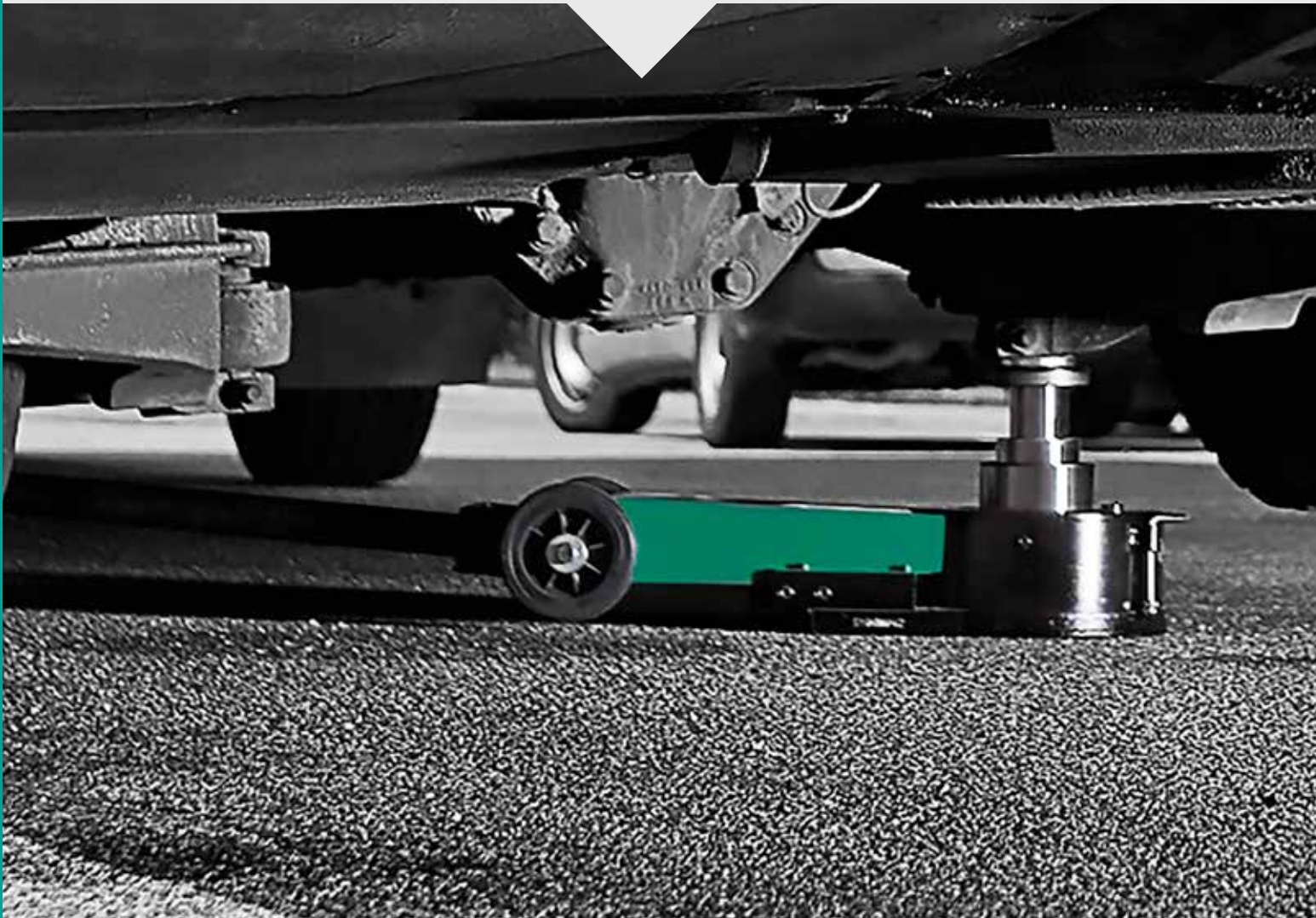

---

## CATALOGUS NR. 12





Hoe Compac waarde creëert

4-7



Lage krikken 2 ton

8



Krikken voor goede toegang onder lage voertuigen 2 ton

9



Krikken voor busjes, 4WD's en minibussen 3 ton

10



Krikken met groot draagvermogen 4 - 15 ton

11



Hooglichters 1,4 - 2 ton

12



Hooglichters 3 - 10 ton

13



Luchthydraulische krikken

14-15



Luchthydraulische krikken

16-18



Hydraulische uitdeukset

19



Wielheffer voor auto's, busjes en 4WD's

20



Wielheffers voor vrachtwagens en bussen

21



Wielheffer voor landbouw- en graafmachines

22-23



Werkplaatskranen

24-25



Universele transmissiekriks

Accessoires voor transmissiekriks

26-27



Telescopische transmissiekriks voor auto's, busjes en 4WD's

28



Telescopische transmissiekriks voor vrachtwagens en bussen

29



Veercompressor

30-31



Voetbediende werkplaatspersen 16 - 30 ton

32



Handbediende werkplaatspersen 20 - 30 ton

33



Voetbediende werkplaatspersen 40 - 50 ton

34



Handbediende werkplaatspersen 40 - 100 ton

35



Elektrohydraulische werkplaatspersen 40 - 100 ton

36-37



Assteunen 2 - 12 ton

Potkriks 3 - 50 ton

38



# HOE COMPAC WAARDE CREËERT **Lifting is serious business – We know!**

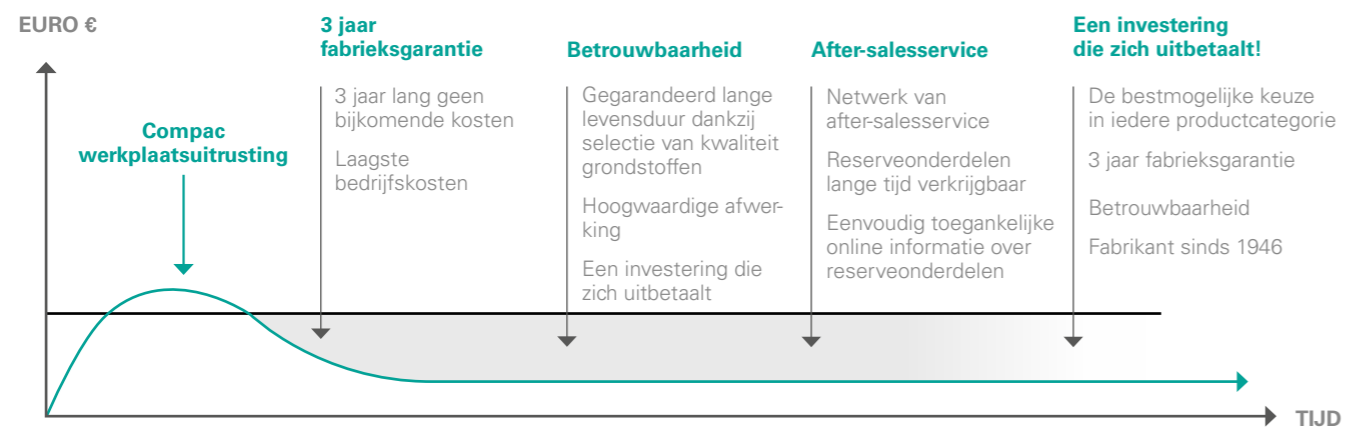

## GESCHIEDENIS

Compac werd in 1946 opgericht door vier enthousiaste en bevoegen Denen. Hun visie: het maken van superieure hydraulische krikken. Nu, 70 jaar later, hebben we nog steeds dezelfde visie. En het is met trots dat we blijven werken aan de verdere versterking van onze reputatie op het gebied van superieure kwaliteit: een reputatie die we in de loop der jaren met grote zorg hebben opgebouwd.



## KENNIS MAAKT HET VERSCHIL



## FABRIEKSGARANTIE

Compac is trendsetter binnen de branche. Als eerste fabrikant biedt Compac namelijk een volledige garantie van 3 jaar.



## FABRIKANT SINDS 1946

Compac produceert al sinds 1946 hydraulische producten van hoge kwaliteit. De ervaren technische medewerkers van Compac halen alles uit de kast om uitstekende kwaliteit te waarborgen en daarmee voor tevreden klanten te zorgen.





## UITSTEKENDE BASISMATERIALEN

De hydraulische componenten van Compac worden in eigen beheer vervaardigd met behulp van hoogwaardige materialen. Belangrijke basismaterialen, zoals de speciale hydraulische buizen, afdichtingen, kleppenblokken, enz., worden uitsluitend ingekocht bij gerenommeerde leveranciers van hoogwaardige basismaterialen. Compac sluit geen compromissen als het gaat om de kwaliteit van de essentiële basismaterialen die in haar hydraulische systemen worden verwerkt.

## LANGDURIGE BESCHIKBAARHEID VAN RESERVEONDERDELEN

U kunt de reserve- en slijtageonderdelen van Compac-producten snel en eenvoudig identificeren en bijbestellen. Uitgebreide en overzichtelijke informatie over de reserveonderdelen van alle Compac-producten vindt u op [www.compac.dk](http://www.compac.dk)



## UNIEK KWALITEITSSYSTEEM

Compac werkt met een uniek kwaliteitssysteem dat is geïnspireerd op de Japanse benadering van kwaliteit. Het strenge kwaliteitssysteem gaat in op zowel de kwaliteitgerichtheid als de persoonlijke verantwoordelijkheid van iedereen die bij het productieproces betrokken is.



## ONLINE INFORMATIE

Snel toegang tot uitgebreide informatie over alle reserveonderdelen. Vind de juiste voordelen voor elke klus. YouTube-filmpjes ter verduidelijking van de voordelen voor de gebruiker. Gebruiksaanwijzingen. Probleemoplossingsgidsen met stapsgewijze instructies om u te helpen bij het ter plekke oplossen van eventuele functionele problemen.



FABRIKANT SINDS 1946







# LAGE KRIKKEN 2 TON AUTO'S



# KRIKKEN VOOR GOEDE TOEGANG ONDER LAGE VOERTUIGEN 2 TON AUTO'S



Ideaal voor hefpunten langs zijpanelen.



Model	Max (ton)	A (mm)	B (mm)	C (mm)	D (mm)	E (mm)	F (mm)	Kg
2T-C	2	80	500	730	160	380	925	36

## ACCESSOIRES

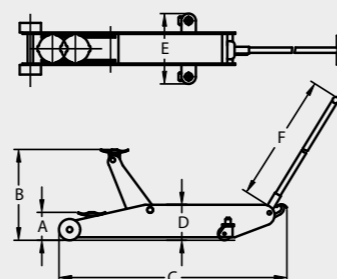
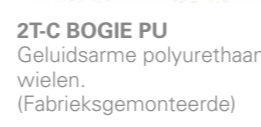
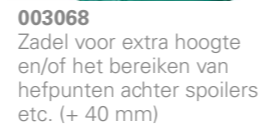

YouTube

Sleutelwoord:  
Compac 2T-77



Extrem laag profiel en lange reikwijdte. Ideaal voor voertuigen met lage spoilers of diep gelegen hefpunten.



Lang bereik van de krik verbetert de bereikbaarheid van diep gelegen hefpunten.



Model	Max (ton)	A (mm)	B (mm)	C (mm)	D (mm)	E (mm)	F (mm)	Kg
2T-77	2	77	480	950	126	380	925	42

## ACCESSOIRES

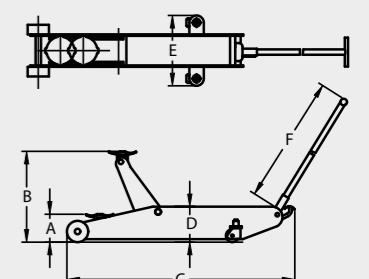
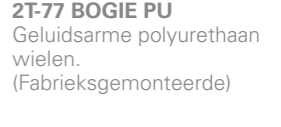
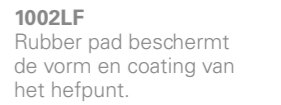





# KRIKKEN 3 TON

## BUSJES, 4WD'S EN MINIBUSSEN



# KRIKKEN MET

## GROOT DRAAGVERMOGEN 4 - 15 TON

### VRACHTWAGENS EN BUSSEN



Door de lage bouwhoogte zijn diep en laag gelegen hefpunten van de meeste auto's bereikbaar.

Lang bereik van de krik verbetert de bereikbaarheid van diep gelegen hefpunten. **10T-C met accessoire 060200**



Model	Max (ton)	A (mm)	B (mm)	C (mm)	D (mm)	E (mm)	F (mm)	Kg
3T-C	3	115	500	1015	170	380	925	43

### ACCESSOIRES

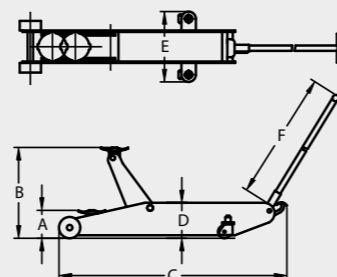

Voetpedaal voor snel heffen tot last.

### ACCESSOIRES



Model	Max (ton)	A (mm)	B (mm)	C (mm)	D (mm)	E (mm)	F (mm)	Kg
4T-C	4	130	545	1270	200	465	1045	74
5T-C	5	145	560	1270	200	465	1045	75
6T-C	6	155	570	1395	210	470	1045	97
10T-C	10	165	580	1410	225	435	1045	110
12T-C	12	170	670	1700	280	470	1045	148
15T-C	15	200	600	1790	325	475	1045	169

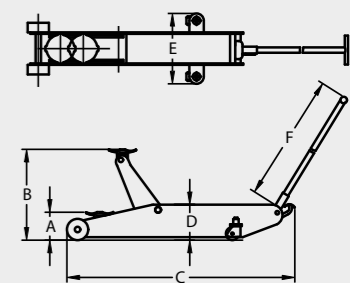





# HOOGLICHTERS 1,4 - 2 TON AUTO'S



# HOOGLICHTERS 3 - 10 TON BESTELWAGENS EN LANDBOUWMACHINES



Max. hoogte 715 mm.

1,4T-HC 77

Voetpedaal voor snel heffen tot last.

Ultra lage bouwhoogte 77 mm.

## ACCESSOIRES

060260  
CSL LED  
Smart  
Licht



Model	Nr.
1,4T-HC 77	001077
2T-HC	1002LF

Rubber pad beschermt de vorm en coating van het hefpunt.



1,4T-HC 77

Zeer lage bouwhoogte met een lengte van 380 mm.

Door de lage profiel zijn diep en laag gelegen hefpunten van de meeste auto's bereikbaar.



1,4T-HC 77 BOGIE PU  
2T-HC BOGIE PU  
Met af fabriek gemonteerde  
Geluidsarme polyurethaan  
wielen.



1,4T-HC 77 HRW  
2T-HC HRW  
Met af fabriek gemonteerde  
hardrubberen wielen.

Veilig en gecontroleerd zakken, zelfs onder maximale belasting.

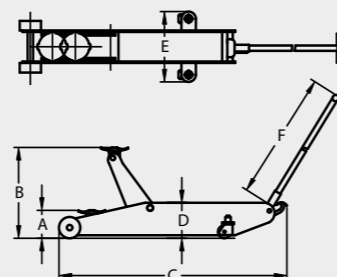

Model	Max (ton)	A (mm)	B (mm)	C (mm)	D (mm)	E (mm)	F (mm)	Kg
1,4T-HC 77	1,4	77	715	1050	190	380	925	52
2T-HC	2	98	735	1035	200	380	1045	56



8T-HC met accessoire 060200



Max. hoogte 860 mm.

De ergonomisch gevormde greep biedt verbeterd bedieningscomfort.

Max. hoogte 960 mm.

Hef en draai veiligheidssysteem van de pomphendel voorkomt onbedoeld zakken.

Veilig en gecontroleerd zakken, zelfs onder maximale belasting.

Zwaar uitgevoerd, volgelaste modellen in hoge kwaliteit staal.

Overdrukventiel beschermt tegen overbelasting.

Extra grote zwenkwielen voor eenvoudig manoeuvreren.

## ACCESSOIRES



060200  
Luchtbandenset bevestigd op het zwaartepunt verbetert de beweegbaarheid van grotere kriks. Banden zakken in bij belasting.



Voetpedaal voor snel heffen tot last.

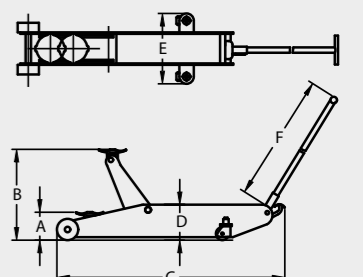





# LUCHTHYDRAULISCHE KRIKKEN VRACHTWAGENS EN BUSSEN



# LUCHTHYDRAULISCHE KRIKKEN VRACHTWAGENS EN LANDBOUWMACHINES



A5816-C



A28-HC

## LAGE TELESCOOP KRIK EN EXTREEM LAGE TELESCOOP KRIK VOOR BUSSEN MET LAGE INSTAP

- Veilig en gecontroleerd zakken, zelfs onder maximale belasting.
- Overdrukventiel beschermt tegen overbelasting.
- Veebelast daal-systeem met dodemansknop.



YouTube Sleutelwoord: Compac A4020-C



YouTube Sleutelwoord: Compac A5816-C

Model	Max (ton)	A (mm)	B1 (mm)	B2 (mm)	B3 (mm)	B4 (mm)	C (mm)	D (mm)	E (mm)	F (mm)	Kg
A3216-C	32/16	150	220	300	-	500	495	168	310	1230	46
A4020-C	40/20	150	220	300	-	500	495	168	310	1230	46
A5816-C	58/32/16	120	165	210	255	455	665	130	305	1360	57

### STANDAARD

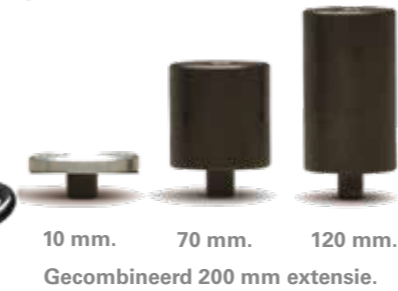

### ACCESSOIRES

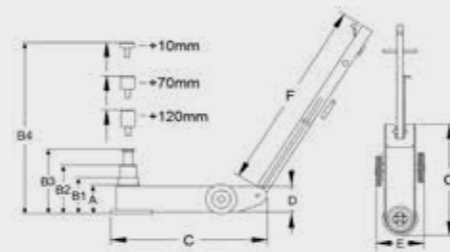

## EXTRA HOGE LUCHTHYDRAULISCHE KRIK EN TELESCOOPKRIK MET EXTRA HOOG HEFVERMOGEN



Model	Max (ton)	A (mm)	B1 (mm)	B2 (mm)	B3 (mm)	B4 (mm)	C (mm)	D (mm)	E (mm)	F (mm)	Kg
A28-HC	28	350	580	-	-	780	735	160	280	1230	64
A4422-C	44/22	220	341	467	-	667	525	168	300	1230	53
A5830-C	58/30	220	330	450	-	650	1050	150	350	1360	80

### STANDAARD

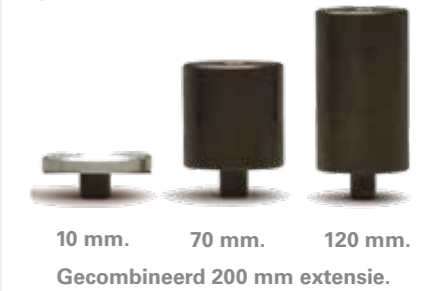

### ACCESSOIRES

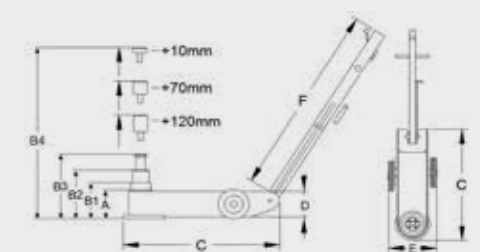





# LUCHTHYDRAULISCHE KRIK 10 TON VRACHTWAGENS EN BUSSEN



# LUCHTHYDRAULISCHE KRIK 10 TON VRACHTWAGENS EN BUSSEN



## STANDAARD



Zadel voor extra hoogte  
+ 70 mm.



Makkelijk te manoeuvreer in de garage en door zijn robuuste constructie een langere levensduur!

*SternPartner,  
Herr Baumgart*



Gebruiksvriendelijk door zijn snelle en stille werking. Het gebruik van perslucht zorgt voor een geluidsniveau van max. 70 dB.

*VEMAS,  
Herr Christian Schmidt*



Eenvoudig te bedienen en universeel toepasbaar! Krik heeft een variabele hoogte van max. 650mm.

*SternPartner,  
Herr Baumgart*



A10T-C



- Veilig en gecontroleerd zakken, zelfs onder maximale belasting.
- Overdrukventiel beschermt tegen overbelasting.
- Veerbelast daal-systeem met dodemansknop.

De hendel is in 45 graden hoek instelbaar voor een eenvoudige manoeuvreerren



YouTube

Sleutelwoord:  
Compac A10T-C

Max. hefhoogte  
580 mm.

Lage bouwhoogte  
225 mm.

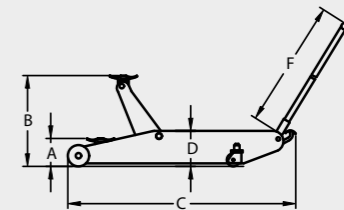
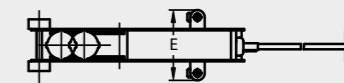

Max. heefhoogte 650 mm when using the extension.



Lage bouwhoogte 150 mm.



Silent wheels for the modern workshop.

Model	Max (ton)	A (mm)	B (mm)	C (mm)	D (mm)	E (mm)	F (mm)	Kg
A10T-C	10	150	580 (650)	1380	225	390	1200	108





# EXTREEM LAAG LUCHTHYDRAULISCHE KRIK 1,6 TON AUTO'S



# HYDRAULISCHE UITDEUKSET AUTO'S, VRACHTWAGENS EN LANDBOUWMACHINES



Lang bereik van de krik verbetert de bereikbaarheid van diep gelegen hefpunten.

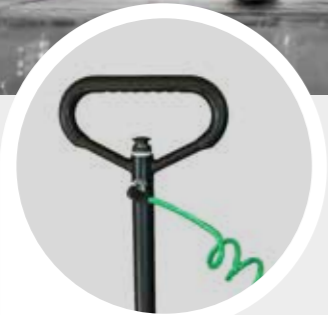

Snelle en stille luchtpomp. Minder dan 70 dB.



Max. hoogte 480 mm.



YouTube

Sleutelwoord:  
Compac A1,6T-77



Extreem laag profiel en lange reikwijdte. Ideaal voor voertuigen met lage spoilers of diep gelegen hefpunten.



Lage bouwhoogte voor bereik onder veel auto's.

Ultra lage bouwhoogte 77 mm.

Lage bouwhoogte.

## ACCESSOIRES

060260  
CSL LED  
Smart  
Licht



001077  
Rubber pad beschermt de vorm en coating van het hefpunt.



003068  
Zadel voor extra hoogte en/of het bereiken van hefpunten achter spoilers etc. (+ 40 mm)



A1,6T-77 HRW  
Met af fabriek gemonteerde hardrubberen wielen.



A1,6T-77 Bogie PU  
Geluidsarme polyurethaan wielen. (Fabrieksgemonteerde)

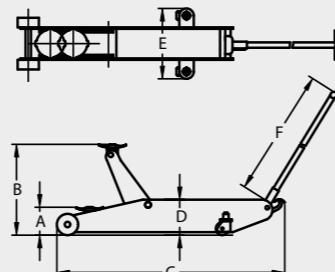

Max. capaciteit 4 ton.

17  
CRK 4  
Gewicht: 19 kg.

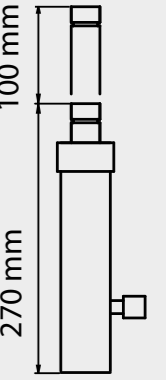

Max. capaciteit 10 ton.

Ideaal bij het opheffen, spreiden en duwen. Hydraulische uitdeuksets zijn geschikt voor diverse toepassingen in schadeherstelbedrijven en in de industrie.

Lange slag.

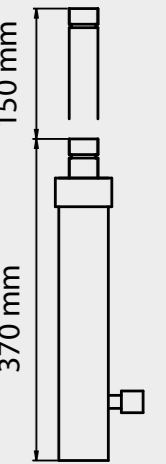

	CRK 4	CRK 10
1	Quick-lock buis, 400 mm.	Quick-lock buis, 475 mm.
2	Quick-lock buis, 300 mm.	Quick-lock buis, 350 mm.
3	Quick-lock buis, 200 mm.	Quick-lock buis, 250 mm.
4	Quick-lock buis, 100 mm.	Quick-lock buis, 125 mm.
5	V-kop.	V-kop.
6	Teen-adaptor met schroefdraad.	Teen-adaptor met schroefdraad.
7	Hoekkop.	Hoekkop.
8	Wigkop.	Wigkop.
9	Basis.	Basis.
10	Zadel.	Zadel.
11	Flexibele rubberkop.	Flexibele rubberkop.
12	Connector.	Connector.
13	Spreider. (Max 500 kg.)	Spreider. (Max 500 kg.)
14	Cilinder.	Cilinder.
15	Flexibele slang, 1800 mm.	Flexibele slang, 1800 mm.
16	4 ton hydraulische voeding.	10 ton hydraulische voeding.
17	Koffer.	Koffer met wielletjes.

CRK 10  
Vægt: 36 kg.

17



WAARSCHUWING: De capaciteit van het hydraulisch systeem overschrijdt het maximum van de spreider en andere adaptors. Zie de gebruikshandleiding voor de maximumcapaciteit per component.





# WIELHEFFER AUTO'S, BUSJES EN 4WD'S



# WIELHEFFERS VRACHTWAGENS EN BUSSEN



Goede toegang tot wielbouten.  
Het wiel bevindt zich aan de andere zijde van de hoofdzuiger.



YouTube

Sleutelwoord:  
Compac WD 60

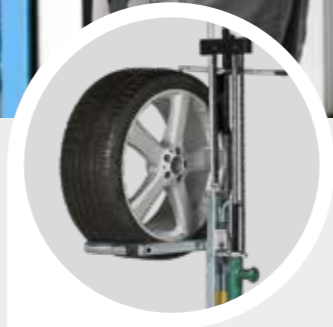

Capaciteit: 60 kg.  
(Buitendiameter max. 820 mm)



Rollen met kogellagers voor makkelijk draaien positioneren.



WD 60



Heffen dankzij voetbediening.

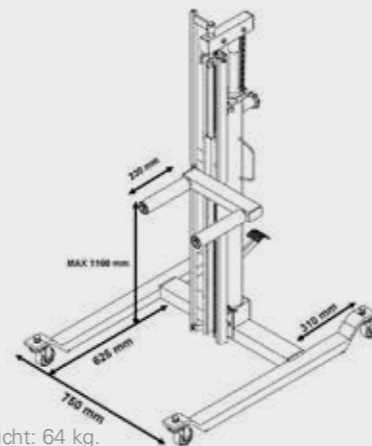

Gewicht: 64 kg.



De wielheffer tilt het wiel rechtstreeks van de grond en voorkomt daarmee zwaar tilwerk.

## MAKKELIJK EN VEILIG MONTEREN, DEMONTEREN EN HANTEREN VAN ZWARE WIELEN VAN VRACHTWAGENS EN BUSSEN

Extra steunwielen voor makkelijk en veilig manoeuvreren, ook bij volledige belading.

Kogelgelagerde rollers voor eenvoudig roteren en positioneren van de wielen op de navens.

Capaciteit 250 kg.

WD MOBILE

Gewicht: 14 kg.



Dankzij de ergonomische hendel is de wielheffer makkelijk te bedienen door slechts één monteur.

Standaard voor snel en eenvoudig opbergen.

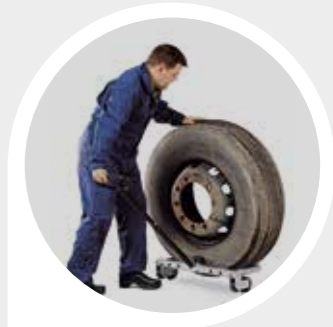

Geschikt voor wielen van maximaal 445/65 - 22,5"

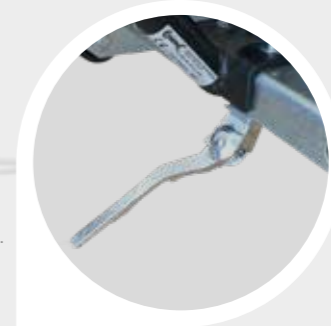

De rollers hebben aan elke zijde drie posities voor verschillende wielmaten.

WD 500  
Capaciteit 500 kg



YouTube

Sleutelwoord:  
Compac WD 500



Makkelijk te manoeuvreren ook bij gebruik.

Voetbediend voor handenvrije daling.



De verstelbare armen maken het mogelijk om wielen met een diameter van 260 mm. tot 1320 mm. te verplaatsen.

Gewicht: 101 kg.

Rollen met kogellagers voor makkelijk draaien positioneren.

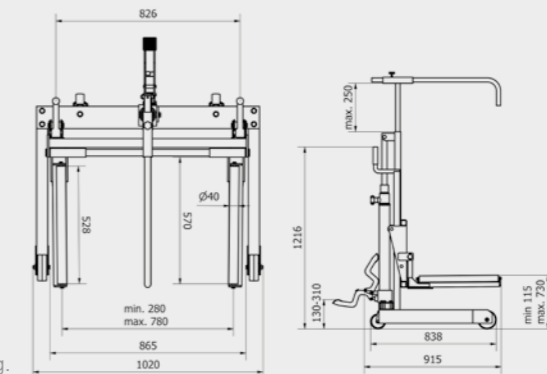





## MAKKELIJK EN VEILIG MONTEREN, DEMONTEREN EN HANTEREN VAN GROTE WIELEN TOT 2400 MM

Dubbelwerkend hydraulisch systeem.  
 Handenvrij schakelen tussen heffen en dalen. Veilig en gecontroleerd dalen.



Geschikt voor grote wielen met een diameter van 1250 mm tot 2400 mm en een diepte van maximaal 1050 mm.



2 x 4 grote rollers voor betere hanteerbaarheid van banden met diep profiel.

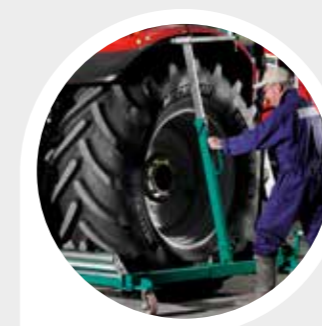

Grote open werkruimte dankzij de ingebouwde hydrauliek.



Handenvrij schakelen tussen heffen en dalen. Veilig en gecontroleerd dalen.

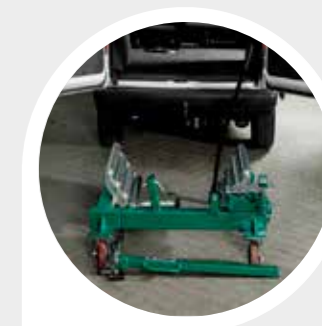

Verrijdbaar: Eenvoudig buiten de werkplaats te gebruiken. Binnen enkele seconden gedemonteerd.



YouTube

Sleutelwoord:  
 Compac WD 1600

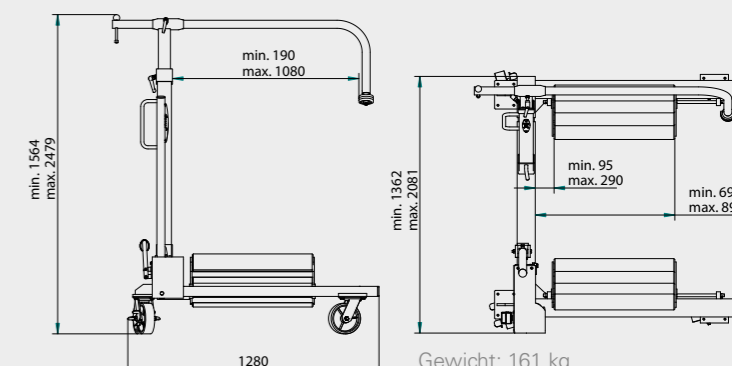





# WERKPLAATSKRANEN AUTO'S



# WERKPLAATSKRANEN AUTO'S EN INDUSTRIEEL GEBRUIK



## ACCESSOIRES



**939010**  
Evenaar.  
Capaciteit 500 kg.

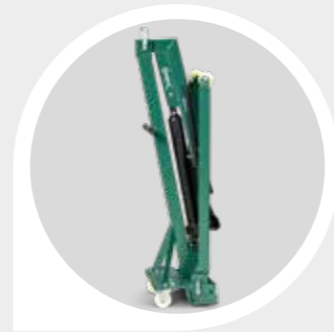

Opvouwbaar. Neemt slechts een beperkte ruimte in. (36 x 42 cm)

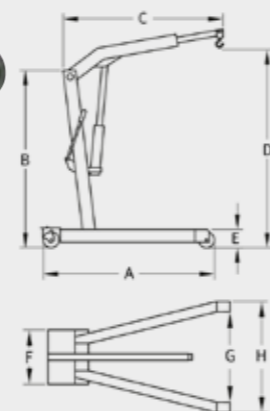
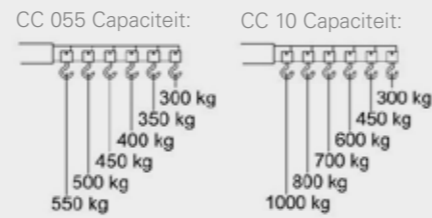

Model	A (mm)	B (mm)	C (mm)	D (mm)	E (mm)	F (mm)	G (mm)	H (mm)	Kg
CC 055	1530	1500	Min. 985 Max. 1435	2120 Max. 550 kg. 2455 Max. 300 kg.	88	440	865	1020	103
CC 10	1530	1500	Min. 985 Max. 1435	2120 Max. 1000 kg. 2455 Max. 300 kg.	88	440	865	1020	103

Het extra lange bereik zorgt voor bedieningsgemak bij motoren van moderne voertuigen.

De draaibare pomphendel maakt bediening door slechts één monteur mogelijk.



CC 10

Werkplaatskraan met hoog vermogen. Voor industriële toepassingen.

De industriële werkplaatskraan past om een standaard EUR-pallet.



CC 15P

CC 15P Capaciteit:

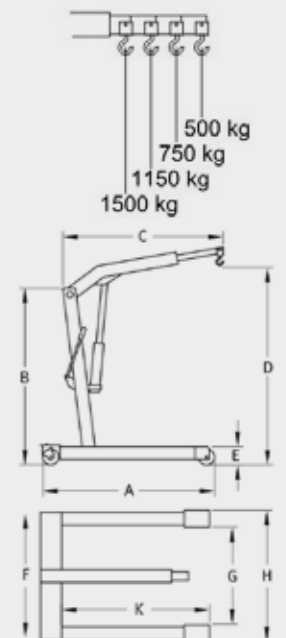

Model	A (mm)	B (mm)	C (mm)	D (mm)	E (mm)	F (mm)	G (mm)	H (mm)	K (mm)	Kg
CC 15P	1720	1860	Min. 1370 Max. 1820	2745 Max. 1500 kg. 3110 Max. 500 kg.	200	1000	850	1015	1570	147





# UNIVERSELE TRANSMISSIEKRIKS AUTO'S EN BUSJES



# ACCESSOIRES VOOR TRANSMISSIEKRIKS AUTO'S EN BUSJES

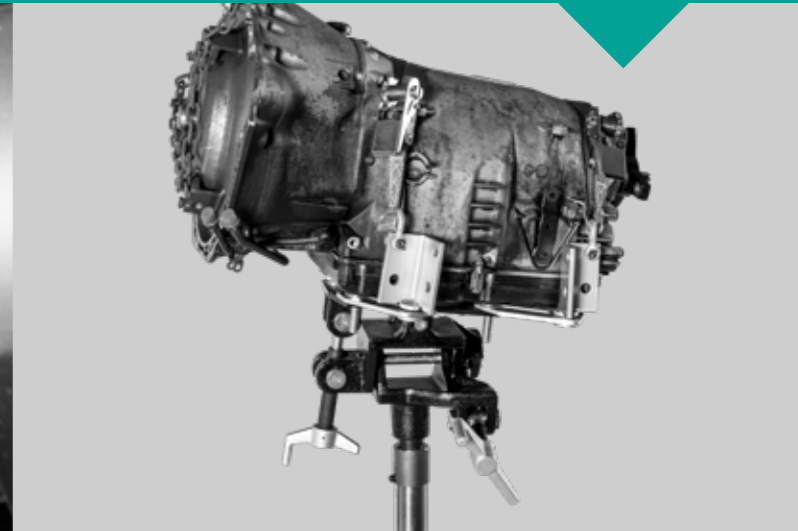

053012/053015

939014



Omkeerbare transmissie-adapter met zadel en rubber pad.

Omkeerbare adapter maakt andere werkzaamheden mogelijk.

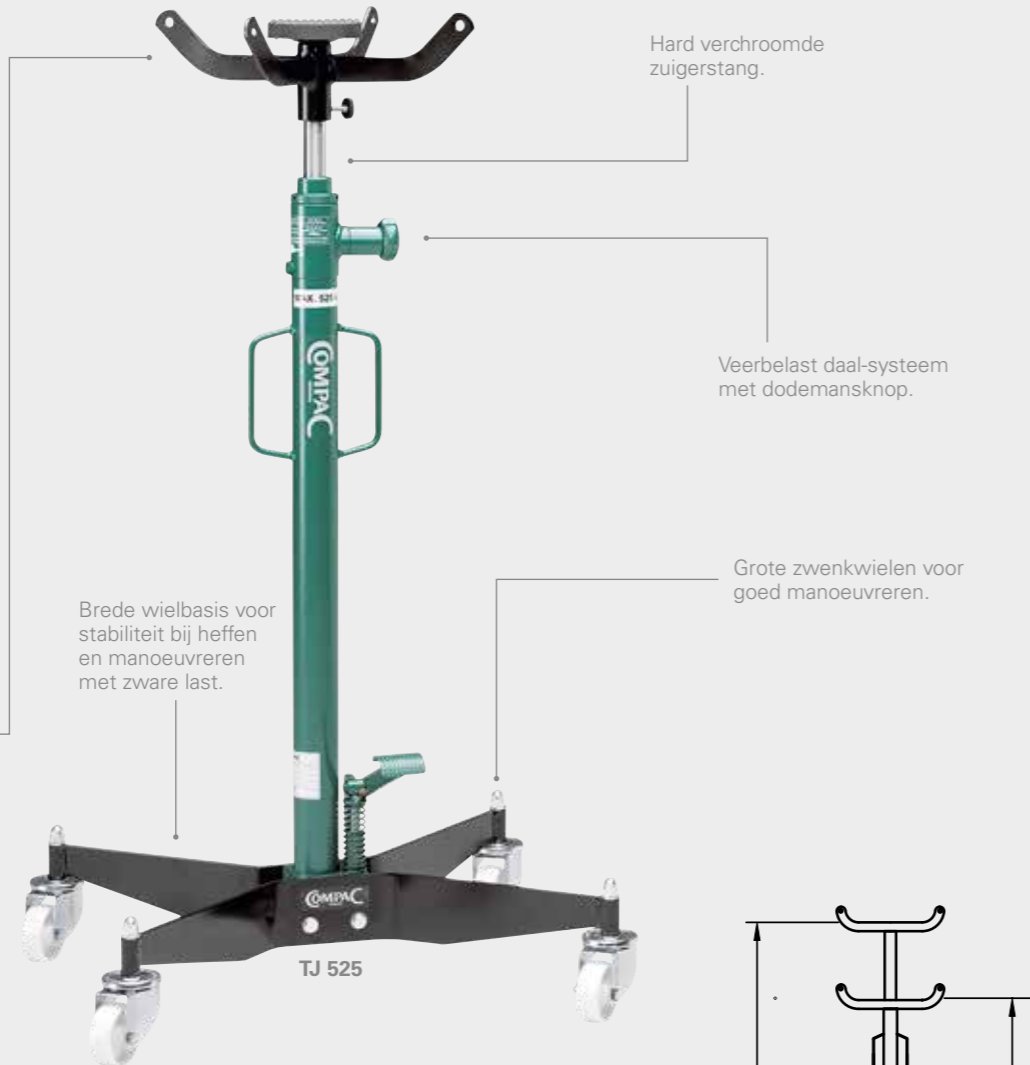

Model	Max (kg)	A (mm)	B (mm)	C (mm)	D (mm)	Kg
TJ 300	300	1095	1930	465 x 565	60	24
TJ 325	325	1170	2020	595 x 535	80	30
TJ 525	525	1170	2020	595 x 535	80	32
TJ 1000	1000	1170	2000	595 x 535	100	38

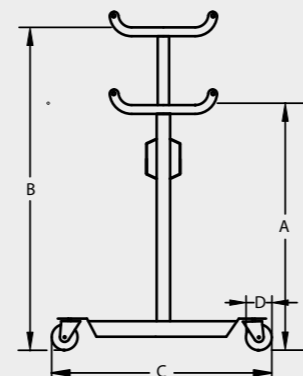

## ACCESSOIRES



Model	Nr.
TJ 300	053012
TJ 325	053012
TJ 525	053012
TJ 1000	053015
TJ-T 1300	053015

**McPherson ondersteuningshaakjes.**  
Voor het ondersteunen en vastzetten van de veerpoot wanneer de monteur aan de wielophanging werkt.

De McPherson veerpootsteun voorkomt dat de poot naar beneden komt bij het demonteren van de veerpoot uit de dwarsverbinding.



Model	Nr.
TJ 300	053004
TJ 325	053004
TJ 525	053005
TJ 1000	053006
TJ-T 1300	053006

**Vloeistoffenafvoerbak met adapter.**  
Multifunctionele vloeistoffenafvoerbak met 18,9 liter capaciteit. Ideaal voor snel en eenvoudig afvoeren van olie.



Model	Nr.
TJ 300	053010
TJ 325	053010
TJ 525	053011
TJ 1000	053013
TJ-T 1300	053013

**Adapter.**  
Adapter zonder de vier armen. Voor betere toegang tot plekken met beperkte ruimte.



Model	Nr.
TJ 300	-
TJ 325	-
TJ 525	939014
TJ 1000	939014
TJ-T 1300	939014

**Verstelbaar transmissie-gereedschap.**  
Voor de positionering en veilig werken aan transmissies. Capaciteit 300 kg.

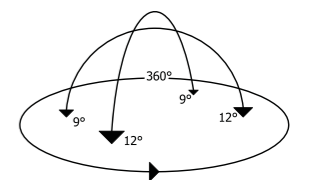





# TELESCOPIsche TRANSMISSIEKRIKS AUTO'S, BUSJES EN 4WD'S



# TELESCOPIsche TRANSMISSIEKRIKS VRACHTWAGENS EN BUSSEN



939014

## ACCESSOIRES

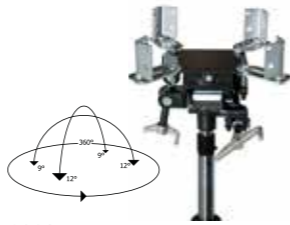

**939014**  
Verstelbaar transmissie-gereedschap. Voor de positionering en veilig werken aan transmissies.

Capaciteit 300 kg.



Omkeerbare transmissie-adapter met zadel en rubber pad.

Omkeerbare adapter maakt andere werkzaamheden mogelijk.

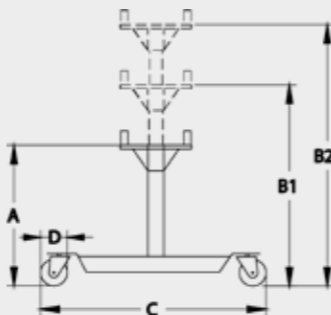

## ACCESSOIRES

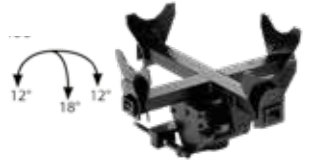

**939007**  
Verstelbaar transmissie-gereedschap, voor de positionering en veilig werken aan transmissies.

Capaciteit 1000 kg.



Model	Max (ton)	A (mm)	B1 (mm)	B2 (mm)	C (mm)	D (mm)	Kg
TJ-T 1300	1.3 / 0.5	1000	1500	2010	760 x 640	100	65

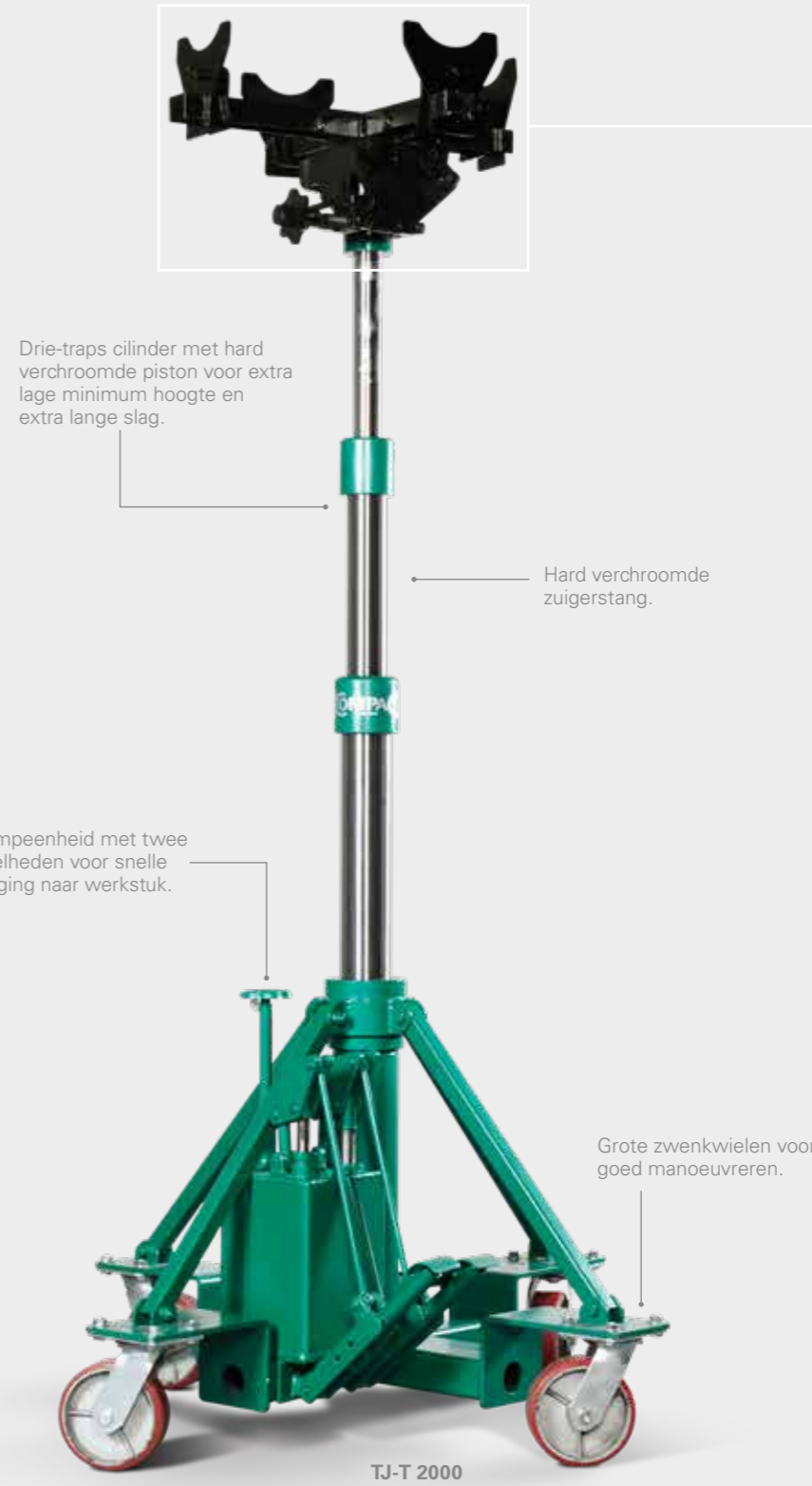

Model	Max (ton)	A (mm)	B1 (mm)	B2 (mm)	B3 (mm)	C (mm)	D (mm)	Kg
TJ-T 2000	2.0 / 1.0 / 1.0	960	1320	1600	1910	1050 x 1050	150	106

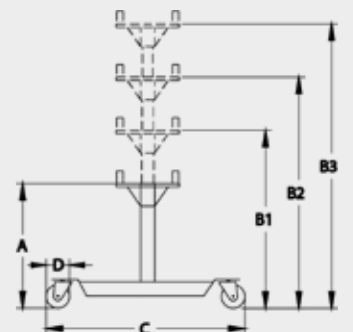





# VEERCOMPRESSOR AUTO'S



# VEERCOMPRESSOR AUTO'S, SUV'S EN BUSJES



## EFFICIËNT, PROFESSIONEEL EN VEILIG DEMONTEN EN MONTEREN VAN MCPHERSON VEERPOTEN

Model						
CSC	✓	✓	✓			

Voor auto's en grotere auto's.



YouTube

Sleutelwoord:  
Compac CSC

### STANDAARD



2 veerhouders  
(Ø78 - 125 mm  
en Ø125 - 200  
mm)

### ACCESSOIRES

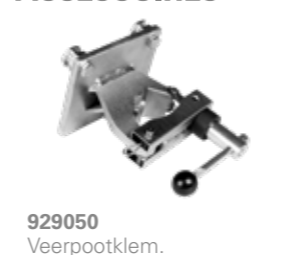

Model						
CSC+	✓	✓	✓	✓	✓	✓

Voor auto's, grotere auto's, SUV's en busjes.



YouTube

Sleutelwoord:  
Compac CSC+

60% EXTRA POWER\*

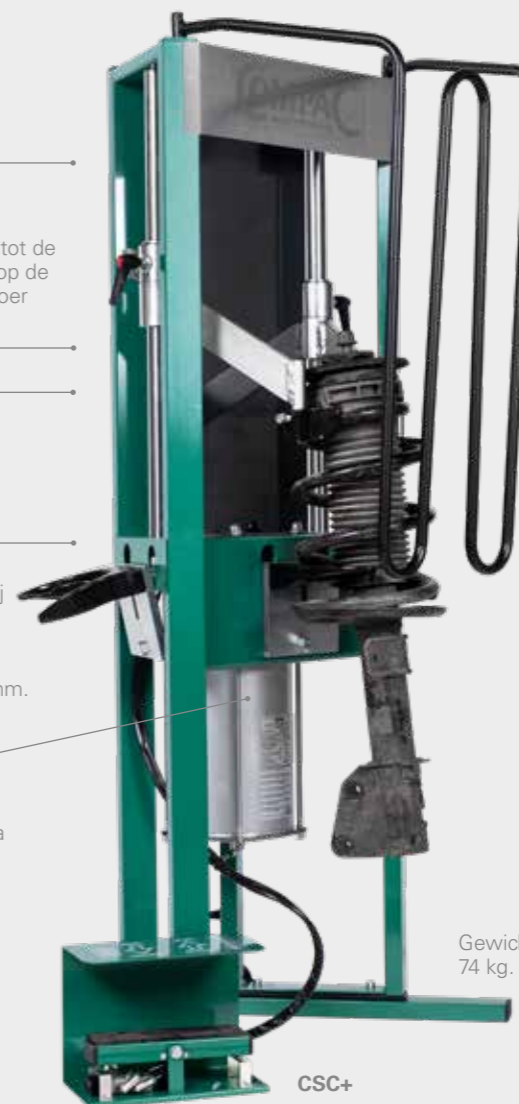

\* CSC+ vergeleken met CSC.

### STANDAARD



2 veerhouders  
(Ø78 - 125 mm  
en Ø125 - 200  
mm)

### ACCESSOIRES

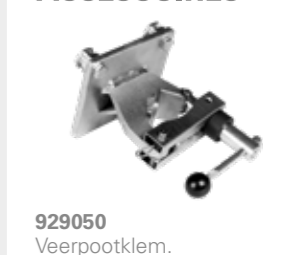

### VEHICLE SPECIFIC SOLUTIONS



929051  
Veerhouder Ø105 - 182 mm. Aanbevolen voor: Renault Megane, Renault Clio, Citroën C3, Citroën C4, Peugeot 208, Peugeot 308, Fiat 500, Toyota Yaris, VW Polo, VW Golf. (Ook inbegrepen in Mercedes kit 929052)







# VOETBEDIENDE WERKPLAATSPERSEN 16 - 30 TON AUTO'S EN BUSJES



# HANDBEDIENDE WERKPLAATSPERSEN 20 - 30 TON AUTO'S EN BUSJES



Verplaatsbare cilinder.

## ACCESSOIRES



**FP 30: Standard** with winch for quick and easy adjustment of table height.

FP 25 with winch: Order model FP 25 W.  
FP 20 with winch: Order model FP 20 W.  
FP 16 is not available with winch.  
Winch can **NOT** be retrofitted!

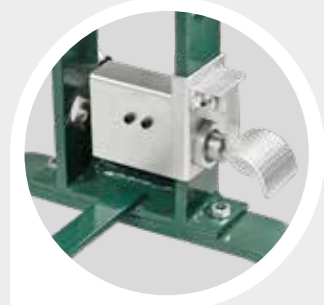

Snelle voetbediende daling van de zuiger op luchtdruk. (FP 20/FP 25/FP 30)

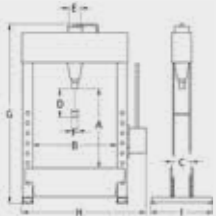

Model	Max (ton)	(mm/stroke)	A (mm)	B (mm)	C (mm)	D (mm)	E (mm)	F (mm)	G (mm)	H (mm)	I (mm)	Kg
FP 16	16	6,0/2,0	1200	550	140	150	65	40	1780	850	600	121
FP 20	20	9,0/1,1	825	600	140	240	90	70	1800	890	505	157
FP 25	25	9,0/1,1	825	600	140	240	90	70	1800	890	505	157
FP 30	30	9,0/1,1	825	600	140	240	90	70	1800	890	505	160

## ACCESSOIRES



**061248** Universele ondersteuning bij verwijderen van lagers.



**061100** Persplaat.



**061240** Opbergvakken.



Model	Nr.
FP 16	061219
FP 20	061216
FP 25	061216
FP 30	061216

**Persstukken.**  
7 stuks, Ø12, 16, 18, 20, 22, 25, 30.



Model	Nr.
FP 16	061220
FP 20	061218
FP 25	061218
FP 30	061218

**Kogellager uitdrukset.**  
4 stuks, Ø 64, 67, 72, 75.



**061242** Protectiescherm.



Verplaatsbare cilinder.

## ACCESSOIRES



**HP 30: Standard** with winch for quick and easy adjustment of table height.

HP 25 with winch: Order model HP 25 W.  
HP 20 with winch: Order model HP 20 W.  
Winch can **NOT** be retrofitted!



Snelle voetbediende daling van de zuiger op luchtdruk.

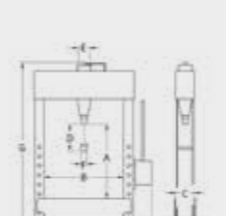

Model	Max (ton)	(mm/stroke)	A (mm)	B (mm)	C (mm)	D (mm)	E (mm)	F (mm)	G (mm)	H (mm)	I (mm)	Kg
HP 20	20	9,0/4,0	825	600	140	240	90	70	1800	890	505	156
HP 25	25	9,0/4,0	825	600	140	240	90	70	1800	890	505	156
HP 30	25	9,0/4,0	825	600	140	240	90	70	1800	890	505	159

## ACCESSOIRES



**061248** Universele ondersteuning bij verwijderen van lagers.



**061100.** Persplaat.



**061240** Opbergvakken.



Model	Nr.
HP 20	061216
HP 25	061216
HP 30	061216

**Persstukken.**  
7 stuks, Ø12, 16, 18, 20, 22, 25, 30.



Model	Nr.
HP 20	061218
HP 25	061218
HP 30	061218

**Kogellager uitdrukset.**  
4 stuks, Ø 64, 67, 72, 75.



**061242** Protectiescherm.





# VOETBEDIENDE WERKPLAATSPERSEN 40 - 50 TON VRACHTWAGENS EN BUSSEN



# HANDBEDIENDE WERKPLAATSPERSEN 40 - 100 TON VRACHTWAGENS EN BUSSEN



## ACCESSOIRES



**061248**  
Universele ondersteuning bij verwijderen van lagers.

Model	Nr.
FP 40	061248
FP 50	061248



De perstafel hoogte kan snel en veilig aangepast worden, door het tandheugel-lier systeem.



Snelle voetbediende daling van de zuiger op luchtdruk.

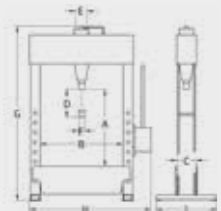

Sleutelwoord: Compac FP 50

Model	Max (ton)	(mm/stroke)	A (mm)	B (mm)	C (mm)	D (mm)	E (mm)	F (mm)	G (mm)	H (mm)	I (mm)	Kg
FP 40	40	6,0/0,8	750	840	200	300	125	70	1990	1350	630	375
FP 50	50	6,0/0,8	750	840	200	300	125	70	1990	1350	630	375

## ACCESSOIRES



**061100**  
Persplaat.



**061240**  
Opbergvakken.



Model	Nr.
FP 40	061216
FP 50	061216

**Persstukken.**  
7 stuks, Ø12, 16, 18, 20, 22, 25, 30.



Model	Nr.
FP 40	061218
FP 50	061218

**Kogellager uitdrukset.**  
4 stuks, Ø 64, 67, 72, 75.



Model	Nr.
FP 40	061243
FP 50	061243

**Protectiescherm.**

## ACCESSOIRES



**061248**  
Universele ondersteuning bij verwijderen van lagers.

Model	Nr.
HP 40	061248
HP 50	061248
HP 60	-
HP 70	-
HP 100	-



De perstafel hoogte kan snel en veilig aangepast worden, door het tandheugel-lier systeem.



Snelle voetbediende daling van de zuiger op luchtdruk.



Model	Max (ton)	(mm/stroke)	A (mm)	B (mm)	C (mm)	D (mm)	E (mm)	F (mm)	G (mm)	H (mm)	I (mm)	Kg
HP 40	40	6,0/1,5	750	840	200	300	125	70	1990	1350	630	374
HP 50	50	6,0/1,5	750	840	200	300	125	70	1990	1350	630	374
HP 60	60	5,0/0,8	760	1005	255	300	160	80	2100	1615	710	690
HP 70	70	5,0/0,8	760	1005	255	300	160	80	2100	1615	710	690
HP 100	100	3,4/0,8	915	1035	305	300	200	100	2200	1637	800	946

## ACCESSOIRES



**061100**  
Persplaat.



**061240**  
Opbergvakken.



Model	Nr.
HP 40	061216
HP 50	061216
HP 60	061228
HP 70	061228
HP 100	061233

**Persstukken.**  
7 stuks, Ø12, 16, 18, 20, 22, 25, 30.



Model	Nr.
HP 40	061218
HP 50	061218
HP 60	061229
HP 70	061229
HP 100	061234

**Kogellager uitdrukset.**  
4 stuks, Ø 64, 67, 72, 75.



Model	Nr.
HP 40	061243
HP 50	061243
HP 60	061245
HP 70	061245
HP 100	061247

**Protectiescherm.**





# ELEKTROHYDRAULISCHE WERKPLAATSPERSEN 40 - 60 TON MET ENKELWERKENDE CILINDER



# ELEKTROHYDRAULISCHE WERKPLAATSPERSEN 40 - 100 TON MET DUBBELWERKENDE CILINDER



## ACCESSOIRES



**061248**  
Universele ondersteuning bij verwijderen van lagers.

Model	Nr.
EP 40	061248
EP 60	-



De perstafel hoogte kan snel en veilig aangepast worden, door het tandheugel-lier systeem.



Dankzij de 90 graden scharnierende pomp kan men makkelijker langere werkstukken invoeren.

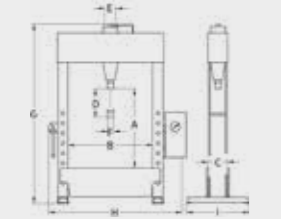

Model	Max (ton)	(mm/stroke)	A (mm)	B (mm)	C (mm)	D (mm)	E (mm)	F (mm)	G (mm)	H (mm)	I (mm)	Kg	Kw
EP 40	40	10,0	750	840	200	300	125	70	1990	1480	630	390	2,2
EP 60	60	10,0/5,0	760	1000	255	300	160	80	2100	1680	710	694	2,2

**Enkelwerkende cilinder:**  
Persen in één richting voor situaties waarbij zwaar gereedschap niet aan de zuigerstang gemonteerd mag worden.



## ACCESSOIRES



**061100**  
Persplaat.



**061240**  
Opbergvakken.



Model	Nr.
EP 40	061216
EP 60	061228

**Persstukken.**  
7 stuks, Ø12, 16, 18, 20, 22, 25, 30.



Model	Nr.
EP 40	061218
EP 60	061229

**Kogellager uitdrukset.**  
4 stuks, Ø 64, 67, 72, 75.



Model	Nr.
EP 40	061243
EP 60	061245

**Protectiescherm.**

## ACCESSOIRES



**061248**  
Universele ondersteuning bij verwijderen van lagers.

Model	Nr.
EP 40 D	061248
EP 60 D	-
EP 100 D	-



De perstafel hoogte kan snel en veilig aangepast worden, door het tandheugel-lier systeem.



Dankzij de 90 graden scharnierende pomp kan men makkelijker langere werkstukken invoeren.

**Dubbelwerkende cilinder:**  
Voor zowel drukken als trekken.



## ACCESSOIRES



**061100**  
Persplaat.



**061240**  
Opbergvakken.



Model	Nr.
EP 40 D	061216
EP 60 D	061228
EP 100 D	061233

**Persstukken.**  
7 stuks, Ø12, 16, 18, 20, 22, 25, 30.



Model	Nr.
EP 40 D	061218
EP 60 D	061229
EP 100 D	061234

**Kogellager uitdrukset.**  
4 stuks, Ø 64, 67, 72, 75.



Model	Nr.
EP 40 D	061243
EP 60 D	061245
EP 100 D	061247

**Protectiescherm.**

Model	Max (ton)	(mm/stroke)	A (mm)	B (mm)	C (mm)	D (mm)	E (mm)	F (mm)	G (mm)	H (mm)	I (mm)	Kg	Kw
EP 40 D	40	10,0	750	840	200	300	125	70	1990	1480	630	396	2,2
EP 60 D	60	10,0/5,0	760	1000	255	300	160	80	2100	1680	710	702	2,2
EP 100 D	100	10,0/1,4	915	1035	305	300	200	100	2200	1780	800	981	2,2





# ASSTEUNEN 2 - 12 TON

# POTKRIKS 3 - 50 TON

## AUTO'S, VRACHTWAGENS EN LANDBOUWMACHINES



SHARK&CO



## ASSTEUNEN

Solide constructie voor uw veiligheid en voor een optimale stabiliteit.

Zwaar uitgevoerd, volgelaste modellen.

Solide poten.  
Solide schroefdraadspil.



Model	Max (ton)	A (mm)	B (mm)	C (mm)	P	Kg
CAX 2H	2	505	755	491	5	6,6
CAX 3	3	346	510	325	5	4,7
CAX 5	5	406	567	355	5	7,2
CAX 8	8	424	633	403	5	11,5
CAX 8H	8	605	870	575	6	15
CAX 12S	12	345	495	230	Spindel	11,6
CAX 12HS	12	505	740	395	Spindel	14,4

## POTKRIKS



Model	Max (ton)	A (mm)	B (mm)	C (mm)	D (mm)	E (mm)	F (mm)	Kg
CBJ 3	3	193	120	60	373	110x103	26	3
CBJ 5	5	210	136	70	416	122x115	30	3,9
CBJ 10	10	230	150	80	460	132x120	36	5,6
CBJ 15	15	230	150	60	440	144x134	43	7,2
CBJ 20	20	242	150	60	452	159x143	46	9,2
CBJ 30	30	275	165	-	440	169x153	49	11,9
CBJ 50	50	265	160	-	425	210x176	83	25,8
CBJ-T 10	10	215	247	78	540	150x145	37	9,3

Compac behoudt zich het recht voor producten uit het programma te verwijderen en/of producten te leveren die afwijken van de illustraties en specificaties.

### Compac Hydraulik A/S

Strandhusevej 43 // 7130 Juelsminde // Denmark // Tel: +45 75 69 37 22 // info@compac.dk  
www.compac.dk